



US007425377B2

(12) **United States Patent**
Fullerton et al.

(10) **Patent No.:** **US 7,425,377 B2**
(45) **Date of Patent:** **Sep. 16, 2008**

(54) **INCOHERENTLY-REVERSING MAGNETIC LAMINATE WITH EXCHANGE COUPLED FERROMAGNETIC LAYERS**

(75) Inventors: **Eric Edward Fullerton**, Morgan Hill, CA (US); **Hoa Van Do**, Fremont, CA (US); **David Thomas Margulies**, Los Gatos, CA (US); **Natacha Supper**, Campbell, CA (US)

(73) Assignee: **Hitachi Global Storage Technologies Netherlands B.V.**, Amsterdam (NL)

(*) Notice: Subject to any disclaimer, the term of this patent is extended or adjusted under 35 U.S.C. 154(b) by 539 days.

(21) Appl. No.: **11/051,536**

(22) Filed: **Feb. 4, 2005**

(65) **Prior Publication Data**
US 2006/0177700 A1 Aug. 10, 2006

(51) **Int. Cl.**
G11B 5/66 (2006.01)
(52) **U.S. Cl.** **428/828**; 428/829; 428/830;
428/216; 360/131
(58) **Field of Classification Search** None
See application file for complete search history.

(56) **References Cited**
U.S. PATENT DOCUMENTS
5,176,965 A 1/1993 Mallary 428/694
5,431,969 A 7/1995 Mallary 427/599
5,736,235 A 4/1998 Matsuda et al. 428/212
5,738,945 A 4/1998 Lal et al. 428/611
5,759,681 A 6/1998 Hosoe et al. 428/332
5,861,220 A 1/1999 Coughlin 428/694
6,007,924 A 12/1999 Lal et al. 428/611

6,043,947 A * 3/2000 Gooch et al. 360/318
6,077,586 A 6/2000 Bian et al. 428/65.3
6,280,813 B1 8/2001 Carey et al. 428/65.3
6,440,589 B1 8/2002 Fullerton et al. 428/694
6,602,612 B2 8/2003 Abarra et al. 428/611
6,645,614 B1 11/2003 Girt et al. 428/336
6,773,834 B2 * 8/2004 Do et al. 428/828
6,777,112 B1 8/2004 Girt et al. 428/694
6,811,890 B1 * 11/2004 Zhou et al. 428/828.1
6,852,426 B1 * 2/2005 Girt et al. 428/611

(Continued)

FOREIGN PATENT DOCUMENTS

JP 63048611 3/1988

(Continued)

OTHER PUBLICATIONS

T. Gouke et al., "Noise Property of Co-Cr-Pt-B Longitudinal Recording Media Separated by a Ru/Co-Cr/Ru Exchange-Coupling Layer", J.Mag.Soc.Jap vol. 28 No. 6, pp. 797-801.

(Continued)

Primary Examiner—Kevin M Bernatz
(74) *Attorney, Agent, or Firm*—Kunzler & McKenzie

(57) **ABSTRACT**

A laminate structure is disclosed comprising multiple ferromagnetic layers achieving incoherent reversal while maintaining good SNR. A high magnetic moment density, low anisotropy field material may form a thin overlayer deposited over a high-anisotropy media layer. The media layer may have a lower magnetic moment density than the overlayer and have decoupled magnetic grains. A coupling layer may be interposed between the overlayer and the media layer to modulate the exchange there between, thereby reducing the pass-through of noise while still promoting incoherent reversal to achieve reduced write energy requirements.

16 Claims, 3 Drawing Sheets

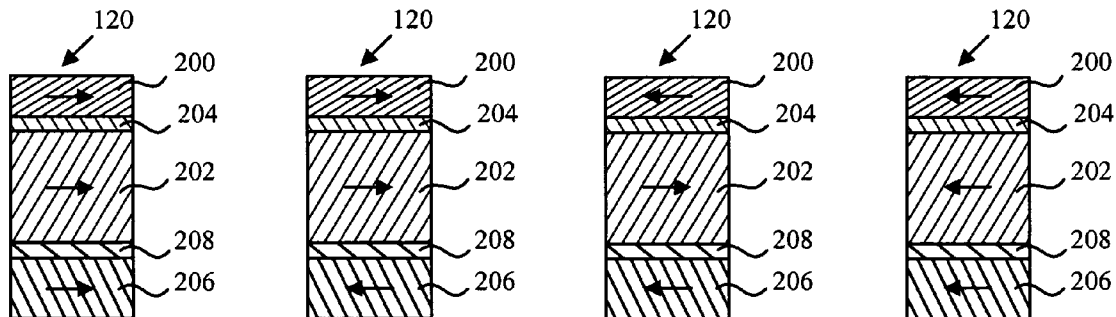

U.S. PATENT DOCUMENTS

6,939,626 B2 * 9/2005 Tang 428/811.2
7,081,309 B2 * 7/2006 Do et al. 428/828.1
7,149,045 B1 * 12/2006 Mallery et al. 360/55
2001/0009727 A1 * 7/2001 Akimoto et al. 428/694 T
2002/0160230 A1 * 10/2002 Yoshikawa et al. 428/694 T
2003/0134150 A1 7/2003 Hong et al. 428/692
2003/0152805 A1 * 8/2003 Bertero et al. 428/692
2003/0170500 A1 * 9/2003 Shimizu et al. 428/694 TM
2004/0166371 A1 8/2004 Berger et al. 428/694

2005/0053803 A1 * 3/2005 Umeda et al. 428/694 T

FOREIGN PATENT DOCUMENTS

JP 3160615 7/1991
JP 2000322724 11/2000
WO WO-93/12928 * 7/1993

OTHER PUBLICATIONS

J.P. Wang et al., "Anti-Ferromagnetic Coupling Effects on Energy Barrier and Reversal Properties of Recording Media", IEEE MAG vol. 37 No. 4, pp. 1445-1448.

* cited by examiner

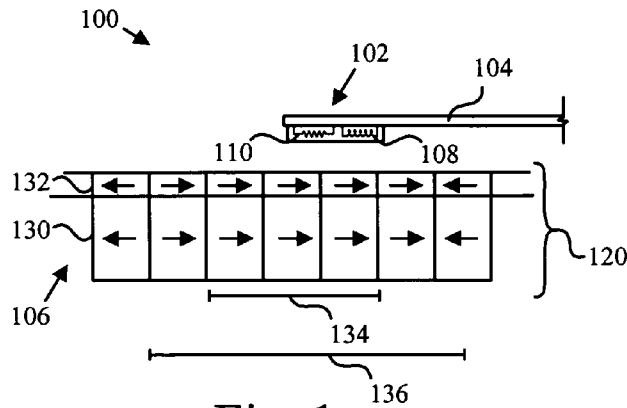

Fig. 1

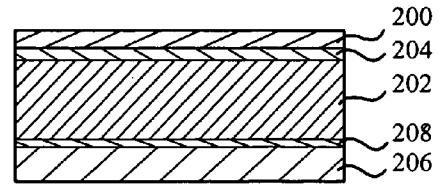

Fig. 2

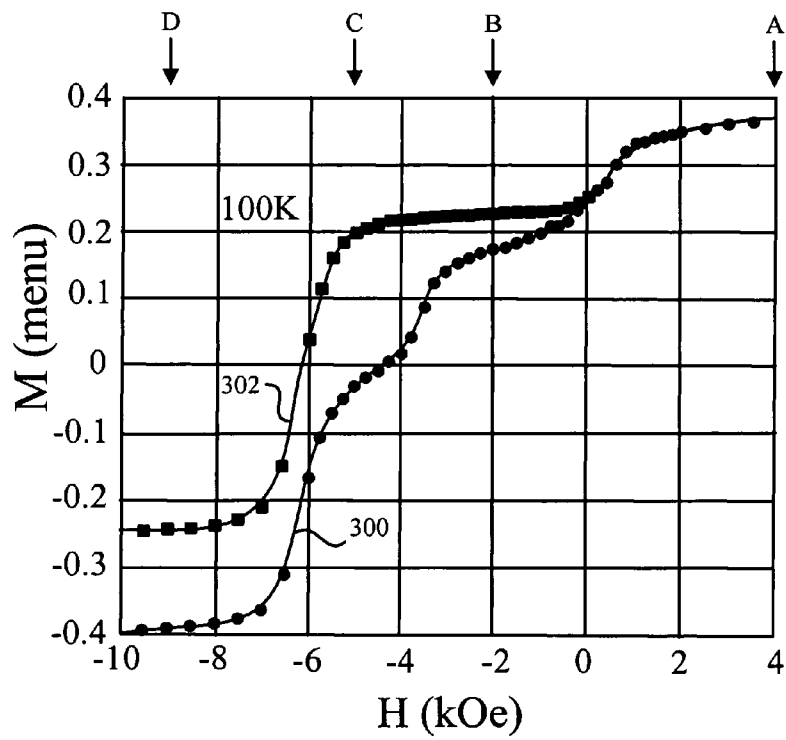

Fig. 3

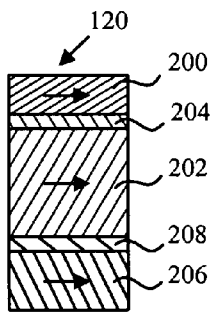

Fig. 4A

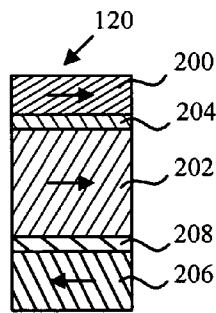

Fig. 4B

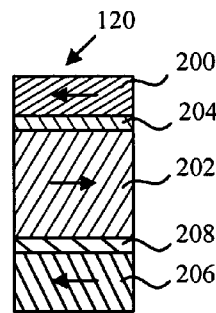

Fig. 4C

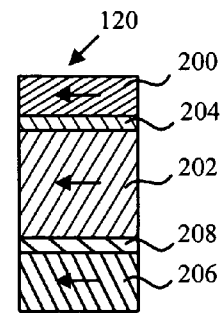

Fig. 4D

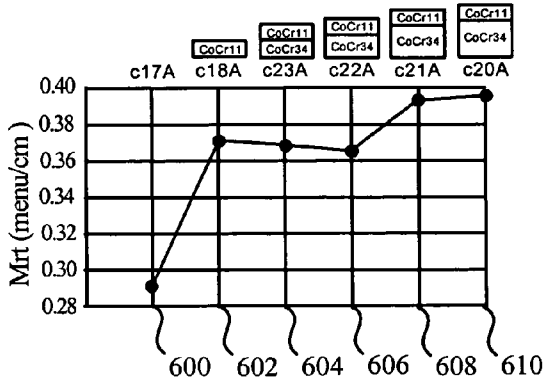

Fig. 5A

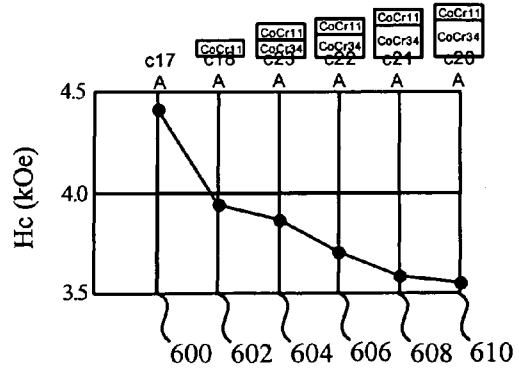

Fig. 5B

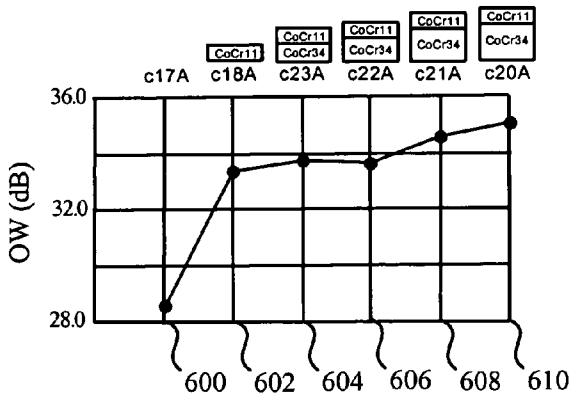

Fig. 5C

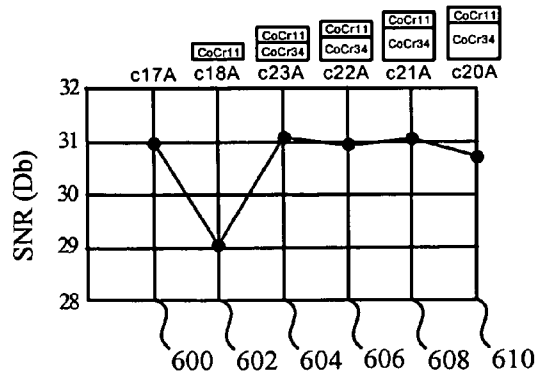

Fig. 5D

INCOHERENTLY-REVERSING MAGNETIC LAMINATE WITH EXCHANGE COUPLED FERROMAGNETIC LAYERS

BACKGROUND OF THE INVENTION

1. Field of the Invention

This invention relates generally to laminate magnetic thin films for data recording and more particularly to magnetic thin films having multiple ferromagnetic layers.

2. Description of the Related Art

FIG. 1 illustrates a typical head and disk system **100** including a magnetic transducer **102** supported by a suspension **104** as it flies above the disk **106**. The magnetic transducer **102**, usually called a "read/write head" or "slider," may include elements that perform the task of writing magnetic transitions (the write head **108**) and reading the magnetic transitions (the read head **110**). The electrical signals to and from the read and write heads **110**, **108** travel along conductive paths (leads), which are attached to or embedded in the suspension **104**. The magnetic transducer **102** is positioned over points at varying radial distances from the center of the disk **106** to read and write circular tracks. The disk **106** comprises a substrate on which a laminate **120** having multiple layers is deposited. The laminate **120** may include ferromagnetic layers in which the write head **108** records the magnetic transitions in which information is encoded.

Extremely small regions, or bits, on the ferromagnetic layers are selectively magnetized in chosen directions in order to store data on the disk **106**. The orientation of the magnetic moments of the magnetized regions is typically longitudinal. That is, the magnetic moments typically point along the plane of the laminate, rather than out of the plane. To increase the amount of data that can be stored on the disks **106** the number of bits per unit area, or storage density, must be increased.

As the storage density of magnetic recording disks has increased, the product of the remanent magnetic moment density (M_r) (the amount of magnetic moments per unit volume of ferromagnetic materials) and the magnetic layer thickness t has decreased. Similarly, values of coercivity (K_c) and anisotropy (K_u) have also increased. However, the extent to which $M_r t$ may be decreased and K_c and K_u may be increased is limited.

To achieve the reduction in $M_r t$, the thickness t of the magnetic layer has been reduced. However, as t is reduced, the magnetic layer exhibits increasing magnetic decay, attributed to thermal activation of small magnetic grains (the superparamagnetic effect). The thermal stability of a magnetic grain is to a large extent determined by $K_u V$, where K_u is the magnetic anisotropy constant of the layer and V is the volume of the magnetic grain. As the layer thickness is decreased, V decreases. If the layer thickness is too thin, the stored magnetic information will no longer be stable at normal disk drive operating conditions. One possible solution to these limitations is to increase the intergranular exchange, so that the effective magnetic volume \bar{V} of the magnetic grains is increased. However, this approach has been shown to be deleterious to the intrinsic signal-to-noise ratio (SNR) of the magnetic layer.

Increasing the values of K_c and K_u increases the amount of energy required to write data to the recording disk. However, write-energy requirements may not exceed the capacity of currently available write heads **108**. The amount of write field required to write to a magnetic film is given by the coercive field H_C which is proportional to the anisotropy field H_K

(approximately equal to K_u/M_s for longitudinal recording media where M_s is the saturation magnetization).

It is known that the write-energy requirements of a high anisotropy field and high coercivity field magnetic layers **130** may be decreased by depositing a layer **132** of thin, high magnetic moment density material with a lower H_K . This high moment material is closer to the write head and more effectively couples the write field and for the proper thicknesses and materials choices can achieve "incoherent reversal." Incoherent reversal results where the high-moment layer changes its orientation in response to an applied field and is no longer collinear with the higher anisotropy layers (**130**) and in turn amplifies the "torque," or reverse field, exerted on the high-anisotropy field layer, causing it to change orientation in response to a weaker applied field than would suffice in the absence of the high-moment layer.

The high-moment layer is magnetically "soft" and can more readily change the orientation of its magnetic moment when a write-field is applied compared to the high anisotropy layer. The change in orientation of the high moment layer causes the magnetic moment of the high-anisotropy field layer to change its orientation slightly, due to the direct exchange between the two layers. It is known that for high-anisotropy field materials, the energy required to cause a change in orientation of the magnetic moments is greatest where the applied field is exactly opposite current orientation. Accordingly, the high-moment layer, by inducing the magnetic moment of the high-anisotropy field layer to shift from a direction directly opposed to the write field, reduces the amount of energy required to cause the high-anisotropy layer to reverse.

The high-moment layer also enables more effective reading and writing to the laminate by concentrating large number of magnetic moments at the top of the media. It is known that reading and writing performance increases with proximity of the transducer **102** to the media. Accordingly, the high-moment layer, due to its direct exchange coupling with the high-anisotropy layer, effectively places the signal, or stored information, in the uppermost layer of the laminate increasing the read back signal and resolution.

Prior systems attempting to achieve the benefits of a high-moment overlayer have significant drawbacks. The high-moment layers tend to have a great deal of intergranular exchange which leads to increased noise and reduced storage density. When the write head **108** applies a field causing the grains in a region **134** to transition, intergranular exchange, will cause the adjoining grains to transition. Accordingly, a larger region **136** will be affected by the write field, thereby increasing the media noise and reducing storage density. SNR is also reduced as writing one bit causes unwanted changes in adjoining bits.

In prior systems, this intergranular exchange in the high-moment layer also affects the high-anisotropy layer. The high-anisotropy layer typically also has a low $M_r t$ and decoupled grains, which tend to reduce noise due to intergranular exchange. However, imposing a high-moment layer on the high-anisotropy field layer results in the noise of the high-moment layer being passed to the high-anisotropy layer.

In view of the foregoing, it would be an advancement in the art to provide a thin film magnetic laminate achieving incoherent reversal while avoiding a reduction in SNR or storage density. It would be an advancement in the art to provide such a film for use in commonly used longitudinal recording media.

SUMMARY OF THE INVENTION

The present invention has been developed in response to the present state of the art, and in particular achieves incoherent reversal of multilayer magnetic laminates while maintaining or increasing SNR. In some embodiments, a laminate **120** may include a thin overlayer located closest to the magnetic transducer **102**, a media layer located beneath the upper magnetic layer, and an antiferromagnetic slave layer beneath the media layer. A coupling layer may be disposed between the overlayer and the media layer and serve to modulate the magnetic exchange between the upper and lower ferromagnetic layers. An antiferromagnetic coupling layer may be disposed between the lower ferromagnetic layer and the antiferromagnetic slave layer and serve to antiferromagnetically couple the lower ferromagnetic layer and the antiferromagnetic slave layer.

The media layer may comprise a magnetic alloy having either a high anisotropy field, decoupled grains, or both. The overlayer may comprise a material having either a high magnetic moment density, a relatively low anisotropy field, or both. The coupling layer may comprise either a ferromagnetically coupling material, a weakly ferromagnetic material, or a paramagnetic material. The coupling layer permits exchange between the overlayer and media layer, however, the exchange may be weaker than direct exchange as when the overlayer is deposited directly onto the media layer.

In the illustrated embodiment, the coupling layer is a CoCr alloys or CoRu alloy. CoCr alloys may have the composition $\text{Co}_{100-x}\text{Cr}_x$, where $26 < x < 40$. CoRu alloys may have the composition $\text{Co}_{100-x}\text{Ru}_x$, where $25 < x < 70$. The overlayer may be embodied as a CoCrB or CoCr alloy. CoCrB alloys may have the composition CoCr_xB_y , where $0 < x < 20$ and $0 < y < 15$. CoCr alloys may have the composition $\text{Co}_{100-x}\text{Cr}_x$ where $0 < x < 20$.

Reference throughout this specification to features, advantages, or similar language does not imply that all of the features and advantages that may be realized with the present invention should be or are in any single embodiment of the invention. Rather, language referring to the features and advantages is understood to mean that a specific feature, advantage, or characteristic described in connection with an embodiment is included in at least one embodiment of the present invention. Thus, discussion of the features and advantages, and similar language, throughout this specification may, but do not necessarily, refer to the same embodiment.

Furthermore, the described features, advantages, and characteristics of the invention may be combined in any suitable manner in one or more embodiments. One skilled in the relevant art will recognize that the invention can be practiced without one or more of the specific features or advantages of a particular embodiment. In other instances, additional features and advantages may be recognized in certain embodiments that may not be present in all embodiments of the invention.

These features and advantages of the present invention will become more fully apparent from the following description and appended claims, or may be learned by the practice of the invention as set forth hereinafter.

BRIEF DESCRIPTION OF THE DRAWINGS

In order that the advantages of the invention will be readily understood, a more particular description of the invention briefly described above will be rendered by reference to specific embodiments that are illustrated in the appended drawings. Understanding that these drawings depict only typical

embodiments of the invention and are not therefore to be considered to be limiting of its scope, the invention will be described and explained with additional specificity and detail through the use of the accompanying drawings, in which:

FIG. **1** is a schematic representation of one embodiment of a read/write head and recording medium comprising a laminate magnetic thin film;

FIG. **2** is an illustration of one embodiment of the layer structure of a laminate magnetic thin film medium, in accordance with the present invention;

FIG. **3** is a hysteresis loop of a laminated magnetic thin film medium, in accordance with the present invention;

FIGS. **4A-4D** are schematic representations of the various layers of a laminated magnetic thin film, in accordance with the present invention, having the orientation of the magnetic moments of the various layers illustrated for various points on the hysteresis loop; and

FIGS. **5A-5D** are plots representing measurements of indicia used to evaluate the performance of a recording medium.

DETAILED DESCRIPTION OF THE INVENTION

Reference throughout this specification to "one embodiment," "an embodiment," or similar language means that a particular feature, structure, or characteristic described in connection with the embodiment is included in at least one embodiment of the present invention. Thus, appearances of the phrases "in one embodiment," "in an embodiment," and similar language throughout this specification may, but do not necessarily, all refer to the same embodiment.

Furthermore, the described features, advantages, and characteristics of the invention may be combined in any suitable manner in one or more embodiments. One skilled in the relevant art will recognize that the invention can be practiced without one or more of the specific features or advantages of a particular embodiment. In other instances, additional features and advantages may be recognized in certain embodiments that may not be present in all embodiments of the invention.

Referring to FIG. **2**, a laminate **120** may include an overlayer **200**, a media layer **202**, and a coupling layer **204**. In some embodiments, the media layer **202** may be antiferromagnetically coupled to an antiferromagnetic slave layer **206** by means of an antiferromagnetically coupling layer **208**.

The overlayer **200** may have a higher magnetic moment density (M_r) than the lower magnetic layer **202**. In some embodiments, the overlayer **200** has a magnetic moment density of approximately 500-1500 emu/cm³, whereas the media layer has a magnetic moment density of 100-500 emu/cm³.

The overlayer **200** may also have a lower magnetic anisotropy field (H_k) than the media layer **202**. In some embodiments, the anisotropy field of the overlayer **200** is less than half the anisotropy field of the media layer **202**. The anisotropies (K_u) of the overlayer **200** and media layer **201** may be identical. However, the anisotropy field H_k (approximately equal to K_u/M_r) of the overlayer **200** may be lower than that of the media layer **202** due to its higher M_r . In terms of writability, the value H_k typically determines the strength of the magnetic field required to cause a change in orientation.

The overlayer may have various embodiments. In one embodiment a CoCrB alloys having the composition CoCr_xB_y , where $0 < x < 20$ and $0 < y < 15$ is used. In others, a CoCr alloy having the composition $\text{Co}_{100-x}\text{Cr}_x$, where $0 < x < 20$ may be used. Various other metals and metal alloys having high magnetic moments and low anisotropies may be used. In the illustrated embodiment the overlayer **200** has a thickness of less than five nanometers.

Due to its lower anisotropy field (H_k), the overlayer **200** is magnetically "soft" and the orientation of its magnetic moments is readily changed by an applied field from the write head **108**. The change in orientation of the overlayer **200** causes the magnetic moment of the media layer **202** to change its orientation slightly, due to coupling between the two layers **200,202** via the coupling layer **204**. For high-anisotropy materials, the energy required to cause a change in orientation of the magnetic moments is greatest where the applied field is exactly opposite the current orientation. Accordingly, the overlayer **200**, by inducing the magnetic moment of the high-anisotropy media layer **202** to shift from a direction directly opposed to the write field, reduces the amount of energy required to cause the media layer **202** to transition.

The overlayer **200** also enables more effective reading and writing to the laminate by concentrating large number of magnetic moments at the top of the laminate **120**. Reading and writing performance increases with the proximity of the transducer **102** to the stored signal. Accordingly, the overlayer **200**, due to its coupling with the media layer **202**, effectively places the signal, or stored information, in the uppermost layer of the laminate. Since the overlayer is a higher moment alloy, the signal originated from an effectively thinner layer than if it were distributed over a much thicker recoding alloy.

The media layer **202** is typically made of a high anisotropy field material that may also be chosen for decoupling of the magnetic grains within the media. In the illustrated embodiment, the media layer **202** is a CoPtCrB alloy. Other ferromagnetic alloys having suitable anisotropy fields, decoupling, and magnetic moment densities may also be used for the media layer **202**.

The coupling layer **204** may be used to reduce the deleterious effects of a high-moment overlayer **200**. As discussed hereinabove, a high-moment, low anisotropy field material is subject to lateral exchange between magnetic grains leading to increased noise and decreased storage density. A coupling layer **204** may modulate the exchange between the overlayer **200** and the media layer **202** to inhibit the transfer of noise to the media layer **202**. The coupling of the layers **200,202** may be weaker than for direct exchange, thereby reducing the transfer of noise from the overlayer **200** to the media layer **202**. Various types of coupling means may be used. For example, the coupling layer **204** may be a nonmagnetic material having a thickness tuned to achieve ferromagnetic coupling. The coupling layer **204** may also be a paramagnetic material or a weakly ferromagnetic layer.

The coupling layer **204** may be formed of various materials known to effectively ferromagnetically couple magnetic layers. For example, a ruthenium layer having a thickness tuned to cause ferromagnetic coupling may be used. In the illustrated embodiment, a CoRu alloy or CoCr alloy having a thickness and composition chosen to achieve ferromagnetic coupling are used. CoRu alloys having the composition $\text{Co}_{100-x}\text{Ru}_x$, where $25 < x < 70$ may be used. CoCr alloys having the composition $\text{Co}_{100-x}\text{Cr}_x$, where $26 < x < 40$ may also be used. The coupling layer may have a thickness of less than four nanometers (nm).

The antiferromagnetic slave layer **206** maybe composed of a material suitable for use in antiferromagnetic media, such as CoCr_1 . The antiferromagnetically coupling layer **208** is typically formed of ruthenium having a thickness chosen to achieve antiferromagnetic coupling.

The hysteresis loop of FIG. 3 demonstrates the embodiment of the laminate of FIG. 2. The measurements shown in FIG. 3 reflect a laminate having a coupling layer **204** formed of a CoRu alloy and is measured from large positive fields to

large negative fields. The loop reflects the change in the number of magnetic moments having a particular orientation, also referred to as saturation, as a reversing field of increasing magnitude is applied to the laminate. The curve **300** represents the major loop, indicating the magnetization in the presence of an applied field. The curve **302** represents the remanent magnetization of the laminate **120** after the applied field is removed. FIGS. 4A through 4D illustrate the orientation of the magnetic moments within each layer **200,202,206** at points A through D on the hysteresis loop.

At point A the magnetic moments of each layer **200,202,206** are at positive saturation oriented in the same direction in an applied field of 4 kOe. As the applied field is reduced to zero, the antiferromagnetic slave layer **206** reverses as shown in FIG. 4B as a result of the antiferromagnetic coupling between itself and the media layer **202**. At point C, approximately 3.5 kOe, the overlayer **200** reverses direction due to the applied field as shown in FIG. 4C. At point D, the media layer reaches negative saturation, as shown in FIG. 4D.

The remanent curve does not reflect the reversal of the overlayer **200** after point C. To the right of point C, the remanent curve **302** has much higher positive saturation than the major loop **300** because the media layer **202** has not reversed at this point and therefore switches the orientation of the overlayer **200** as soon as the applied field is removed, due to the coupling between the layers **200,202**. The remanent curve also reflects the reversal of the antiferromagnetic slave layer **206** when the applied field is removed at point D: the negative saturation of the remanent curve **302** is less than the major loop because the antiferromagnetic slave layer **206** reverses direction in the absence of an applied field due to its antiferromagnetic coupling to the media layer **202**.

Referring to FIGS. 5A-5E, measurements of indicia used to evaluate recording performance clearly indicate improved overall performance through the use of a coupling layer **204** modulating the exchange between the layers **200,202**. The values in column **600** represent measurements of a media layer **202** without an overlayer **200** or coupling layer **204**. The values in column **602** represent measurements of a media layer **202** with an overlayer **200** but without a coupling layer **204**. The values in columns **604-610** represent measurements of media layers **202** with an overlayer **200** and coupling layers **204** of increasing thicknesses. The thickness of the coupling layer **204** increases from right to left.

Referring to FIG. 5A, it is clear that the M_t of columns **602-610** is greater than for the laminate of column **600**, which does not have an overlayer **202** or coupling layer **204**. This demonstrates the composite magnetization of the media increases as the high moment over is added.

Referring to FIG. 5B, smaller values for H_c correspond to smaller write-energy requirements. It is clear from column **602** that the addition of an overlayer **200** reduces H_c . It is also clear from columns **604-610** that adding a coupling layer **204** and increasing the thickness of the coupling layer **204** further reduce H_c . It will be noted that the measurements of FIG. 6B are of the effective H_c of the entire laminate **120**. However, the composition of the media layer **202** and the H_c of the media layer **202** are unchanged. Accordingly, the thermal stability of the media layer **202** is not affected, whereas the writability of the laminate **120** improves with the addition of an overlayer **202** and a coupling layer **204**.

Referring to FIG. 5C, use of an overlayer **200** and coupling layer **204** also increases the ability of the laminate **120** to be overwritten. As shown by column **602** an overlayer **200** increases overwrite (OW) performance. As shown by col-

7

umns 604-610, adding a coupling layer further increases OW with further gains being achieved with increased thickness of the coupling layer 204.

The above mentioned gains in OW performance are all accomplished without a reduction in SNR where a coupling layer 204 is used as shown in FIG. 5D. Column 602 indicates an increase in noise where an overlayer 202 is added without a coupling layer 204 to modulate the exchange between the overlayer 202 and the media layer 204. Columns 604-610 clearly show that SNR is improved where a coupling layer 204 is interposed between the layers 200,202.

The present invention may be embodied in other specific forms without departing from its spirit or essential characteristics. The described embodiments are to be considered in all respects only as illustrative and not restrictive. The scope of the invention is, therefore, indicated by the appended claims rather than by the foregoing description. All changes which come within the meaning and range of equivalency of the claims are to be embraced within their scope.

What is claimed is:

1. A laminate recording medium comprising:
 - an upper magnetic layer having a first thickness, a first magnetic anisotropy field, and a first magnetic moment density, the upper magnetic layer comprising magnetic grains;
 - a lower magnetic layer having a second thickness, a second magnetic anisotropy field, and a second magnetic moment density, the second magnetic anisotropy field being greater than the first anisotropy and the first magnetic moment density being higher than the second magnetic moment density, the lower layer comprising magnetic grains, the magnetic grains of the lower layer having a greater degree of decoupling than the magnetic grains of the upper layer; and
 - a coupling layer disposed between the upper and lower layers, the coupling layer being a material chosen from the group consisting of ferromagnetically coupling materials.
2. The laminate of claim 1, wherein the upper layer has a magnetic moment density of about 500 to 1500 emu/cm³ and wherein the lower layer has a magnetic moment density of about 100 to 500 emu/cm³.
3. The laminate of claim 2, wherein the first anisotropy field is less than half the second anisotropy field.
4. The laminate of claim 1, wherein the coupling layer is a ferromagnetically coupling material ferromagnetically coupling the upper and lower magnetic layers.
5. The laminate of claim 1, wherein the coupling layer has a thickness less than four nanometers.
6. The laminate of claim 1, wherein the second magnetic anisotropy field is longitudinally oriented.

8

7. The laminate of claim 1, wherein the second thickness is greater than the first thickness.

8. The laminate of claim 7, wherein the first thickness is less than five nanometers.

9. A laminate comprising:

- an upper layer having a first thickness, a first anisotropy, and a first magnetic moment density, the upper layer comprising magnetic grains;
- a lower layer having a second thickness, a second anisotropy, and a second magnetic moment density, the first magnetic moment density being greater than the second magnetic moment density, the lower layer having the magnetic moments thereof oriented longitudinally, the lower layer comprising magnetic grains, the magnetic grains of the lower layer having a greater degree of decoupling than the magnetic grains of the upper layer; and
- a coupling layer disposed between the upper and lower layers.

10. The laminate of claim 9, wherein the coupling layer ferromagnetically couples the upper and lower layers.

11. The laminate of claim 9, wherein the second thickness is greater than the first thickness.

12. A recording device comprising:

- a transducer for inducing and detecting magnetic fields;
- a rotatable medium comprising
 - an upper layer positioned proximate the transducer head, the upper layer comprising magnetic grains,
 - a lower layer positioned beneath the upper layer, the lower layer comprising magnetic grains, the magnetic grains of the lower layer having a greater degree of decoupling than the magnetic grains of the upper layer, and
 - a coupling layer modulating magnetic exchange between the upper and lower layer,
 - the upper layer having a higher magnetic moment density and a lower anisotropy than the lower layer, the anisotropy of the lower layer being oriented longitudinally.

13. The recording device of claim 12, further comprising:

- a slave layer positioned beneath the lower layer; and
- an antiferromagnetic coupling layer disposed between the slave layer and the lower layer.

14. The recording device of claim 12, wherein the upper layer comprises an alloy chosen from the group of CoCrB alloys and other CoCr alloys.

15. The recording device of claim 14, wherein the upper layer is CoCr_xB_y, where 0<x<20 and 0<y<15.

16. The recording device of claim 14, wherein the upper layer is Co_{100-x}Cr_x where 0<x<20.

* * * * *